

Non-isolated DC-DC **POL** converter

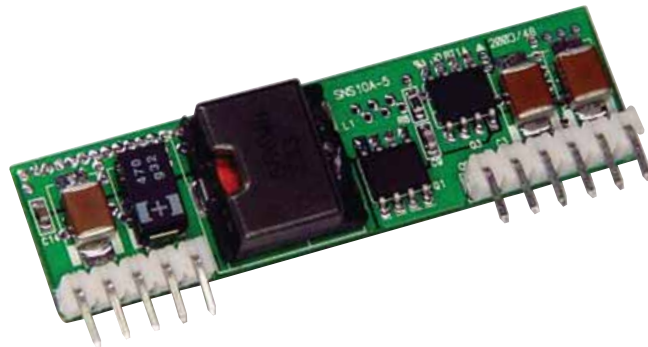

Total output current	10 A
Input voltages	12 V Input
#of outputs	Single output

SPECIAL FEATURES

- Delivers 10A of output Current
- High efficiency
- Low Output Ripple & Noise
- Small size and low profile 50.80mm×13.97mm×8.64mm (SIP package)
- Cost-efficient open frame design
- Single - in - line (SIP) & SMT package
- Remote ON/OFF (active low)
- Trimmable output voltage via external resistor
- Output Over current protection
- Over temperature protection
- Wide Operating temperature range -40°C~85°C

ELECTRICAL SPECIFICATIONS

- Efficiency 95% @5.0V
- Input voltage range 10.0V - 14.0V
- Output voltage 1.0V - 5.0V
- Voltage tolerance ± 2.0%
- Line regulation 0.3%
- Load regulation 0.4%
- Switching frequency 300KHz
- *Ripple & noise 50mVp-p (@5.0V)
- MTBF 7.6×10^5 hrs

NOV.05.2004

*Ripple & noise is tested / specified over a 20MHz bandwidth and may be reduced with external filtering.

Non-isolated DC-DC POL converter

SNS10A-12

NOV.05.2004

Ordering Information

Input	Output	Maximum Power	Ripple&Noise max	Efficiency Typ.	Model Number
10- 14V	1.0V@10A	10.0W	50mVp- p	83%	SNS10A- 12- 1R0
10- 14V	1.5V@10A	15.0W	50mVp- p	85%	SNS10A- 12- 1R5
10- 14V	1.8V@10A	18.0W	50mVp- p	89%	SNS10A- 12- 1R8
10- 14V	2.5V@10A	25.0W	50mVp- p	92%	SNS10A- 12- 2R5
10- 14V	3.3V@10A	33.0W	50mVp- p	93%	SNS10A- 12- 3R3
10- 14V	5.0V@10A	50.0W	50mVp- p	95%	SNS10A- 12- 5R0

1. Typical at $T_a = +25^\circ\text{C}$ under nominal line voltage and full load conditions, unless otherwise noted. All models are tested and specified with external input and output capacitors. ($C_{in} = 100\mu\text{f}$ X2 $C_{out} = 10\mu\text{f}$). These capacitors are necessary to accommodate Our test equipment
2. Ripple & Noise is tested / specified over a 20MHz bandwidth and may be reduced with external filtering. See I/O Filtering
3. These device have no minimum-load requirement and will regulate Under no-load conditions. Regulation specification describe the output voltage deviation as the line voltage or load is varied from its minimum value to either extreme.

Pin Assignment & Dimension

Single Output (SIP)

1. + Vout
2. + Vout
3. Sense
4. + Vout
5. COM
6. COM
7. + Vin
8. + Vin
9. No Pin
10. TRIM
11. ON/OFF

Single Output (SMT)

1. Sense
2. Trim
3. + Vout
4. COM
5. + Vin
6. ON/OFF

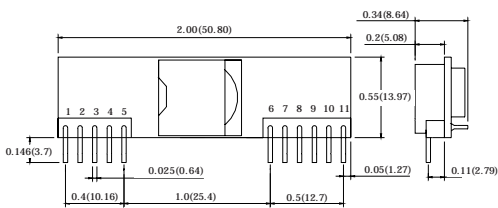

<SIP TYPE>

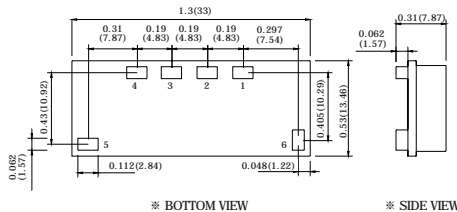

<SMT TYPE>

- NOTES
1. All dimensions are in inches (mm)
 2. Weight : 7.5g or less (SIP)
5.6g or less (SMT)

Circuit Diagram

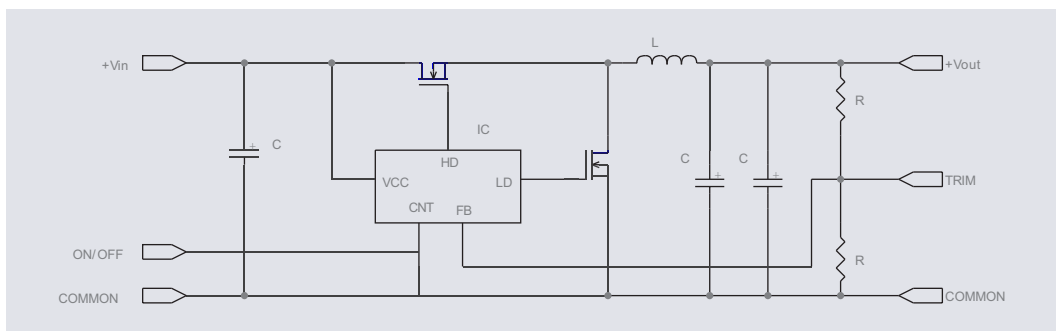

Non-isolated DC-DC POL converter

SNS10A-12 Performance / Functional Specification

NOV.05.2004

Absolute Maximum Ratings

Input Voltage : Continuous or transient	14V
On/Off Control	+Vin
Input Reverse-Polarity Protection	None
Output Overvoltage Protection	None
Output Current	10A
Storage Temperature	-40°C to 125°C
Lead Temperature (Soldering, 10sec)	+300°C

These are stress ratings. Exposure of device to any of these conditions may adversely affect long-term reliability. Proper operation under conditions other than those listed in the Performance/Functional Specifications Table is not implied.

Input

Input Voltage Range	10V - 14V (12V nominal)
Standby/off Mode	2mA
Input Filter Type	Capacitive
Over Voltage Protection	None
Reverse Polarity Protection	None
Undervoltage Shutdown	8.0V Typ.
On/Off control	On = Open, 0~1.0V Off = +1.2V to +Vin

Output

Vout Accuracy	± 2%
Minimum Loading	No Load
Vout Trimming Range	± 10%
Ripple/Noise (20MHz BW)	See Ordering Information
Line / Load Regulation	0.3% / 0.4%
Efficiency	See Ordering Information
Over Current Detection and Short-Circuit Protection :	
Current - Limiting Detection Point	180% typ.
SC Protection Technique	Hiccup with auto recovery
Switching Frequency	300KHz (+40KHz, -50KHz)

Dynamic Characteristics

Transient Response (50% load step)	Preparing
Output Rise Time	
Vin to Vout	4 msec
On/Off to Vout	4 msec

Physical

Dimensions	See Dimension Specifications
Package	Single-in-line(SIP), SMT Package
Pin Material	Brass, Copper under coated
Weight	7.5g(SIP), 5.6g(SMT)
Pin Flamability Rating	UL94V-0 / Nylon 66

Environmental

Calculated MTBF : 25°C Full load, Natural convection	7.6X10 ⁶ hrs
Operating Temperature : (Ambient)	-40°C to 85°C
Without Derating (Natural convection)	See Derating Curve
With Derating	See Derating Curve
Thermal Shutdown	+135°C

Test Configurations

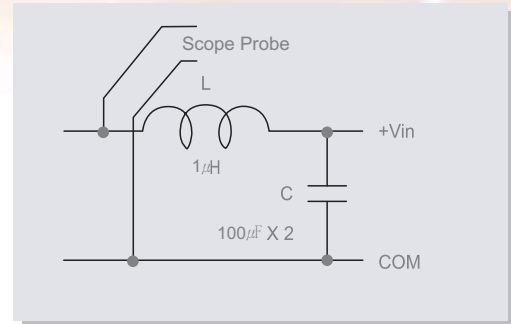

Fig1. Input Reflected Ripple Voltage Test Setup

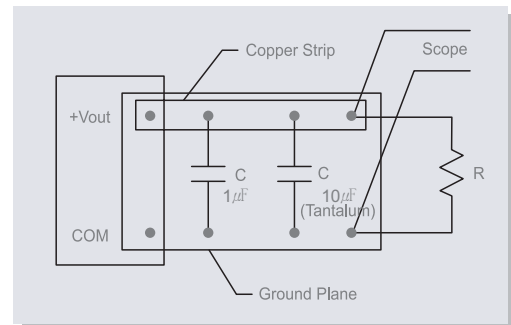

Fig2. Output Ripple and Noise Test Setup

Application Note

I/O Filtering and Noise Reduction

To minimize the ripple and noise of the input voltage, Low-ESR polymer and ceramic capacitors are required at the input of the device. The data of input reflected current/voltage and output ripple voltage are tested and specified with the external capacitor as shown in Fig1 and Fig2. These capacitors can improve a performance of the device and may not be required to your application.

Low inductive source is recommended. High inductive source usually may cause a negative effect on stability of the device. For a stability of the device, input capacitors must be installed as close to input of device as possible.

To minimize the output voltage ripple and noise, Low-ESR polymer and ceramic capacitor are required at the output of the device. SNS Series are designed for low output ripple and noise and output ripple and noise can be further reduced by adding an external output capacitors. With additional 1uF ceramic and 10uF tantalum capacitor at the output of the device, output ripple and noise will meet our maximum specification.

To improve a dynamic response of step load variation and reduce the output ripple, Low-ESR polymer and ceramic capacitor should be placed as close to the output of the devices as possible.

Input Voltage or Reverse-Polarity Voltage protection

SNS Series are not equipped with an input overvoltage protection circuit and reverse-polarity protection circuit. Therefore, the components and device may be damaged permanently in case of exceeding the absolute maximum input voltage or reverse-polarity voltage for longer than instantaneous.

Input undervoltage lockout

SNS series does not operate under the input voltage condition lower than input undervoltage lockout limit. As soon as input voltage exceeds undervoltage lockout turn-on threshold, the device may go into an operation.

Output overvoltage protection

SNS Series are not equipped with an overvoltage protection circuit. If feedback-loop is broken, it may boost the output voltage up to high level ($V_{out} = V_{in}$). If you need imperatively overvoltage protection function for all possible overvoltage situations, voltage limiting circuit must be designed at the external output of the device.

Output Overcurrent Protection

Output current should not exceed a maximum rating of the device. The overloading state exceeding maximum rating at the output of the device for an extended time will occur high temperatures of internal component. Consequently, the device and components may be broken down.

SNS Series are equipped with an output overcurrent detection circuit. If the output current exceeds more than 80% of maximum original value, overcurrent detection circuit operates, then goes into a Hiccup mode sequentially. If output overcurrent state is removed, the converter will return to normal operation automatically.

Input Fusing

SNS10A-12 is not internally fused. Therefore, a slow acting fuse with a maximum rating of 15A should be installed in the ungrounded input of these unit.

I/O Filtering and Noise Reduction

Even though SNS series are designed to operate in the various ambient temperatures, it should be required a enough cooling system for more reliable operation. Thermal derating data is obtained by measurement of the airflow values provided to the long axis of the device Fig 3.

Thermal derating curves provide designers with a quantity of a current under the desired ambient temperature and velocity of a airflow. The thermal data is the data measured in the wind tunnel. Fig4 shows a test setup.

The SNS Series's overthermal protection function depends on thermal protection feature of the main IC. If a temperature of the device exceeds the thermal reference point ($T_{ref} = 135^{\circ}\text{C}$), the device becomes shut-down automatically. Thermal shut-down function does not mean that it turn off the device when beyond its rating. Once a temperature drops, the device will automatically restart itself.

If the device is installed in a system, the device's temperature should be checked it does not exceed 110°C (FET).

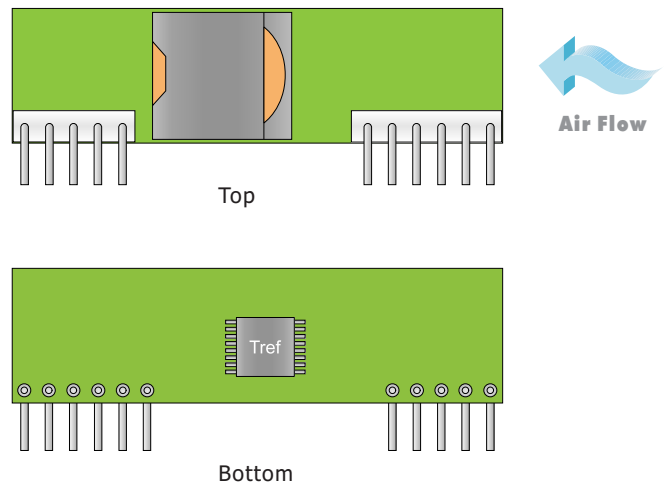

Fig3. Thermal Measurement location

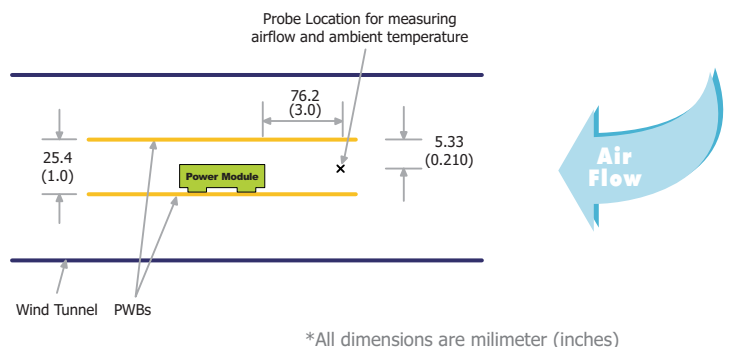

Fig4. Test Setup of the Thermal Data

*All dimensions are millimeter (inches)

Non-isolated DC-DC POL converter

SNS10A-12

NOV.05.2004

Remote On/Off Control

On/Off control pin can be used for ON/OFF operation. When ON/OFF pin is open or low(0 to +1.0V), SNS Series are enabled. Also, SNS Series are disabled when On/Off control pin is high state(+1.2 to +Vin).

Remote On/Off control pin can be switched by connecting open collector pnp transistor in Fig5 or open-drain logic device with external pull-up resistor in Fig6 between ON/OFF- pin and Vin-pin

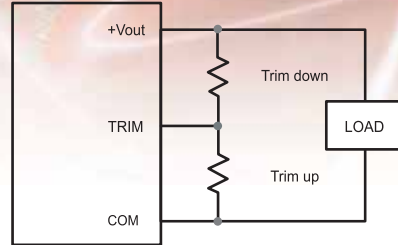

Fig5. Trim Connecting Using Fixed Resistor

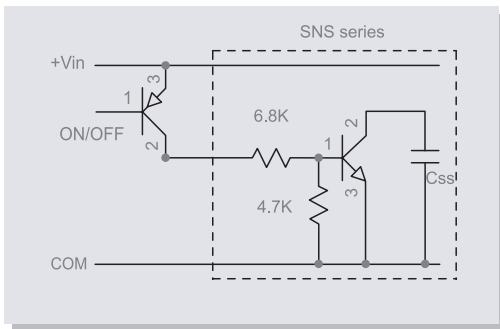

Fig5. Driving the ON/OFF Control Pin with and Open Collector Drive Circuit

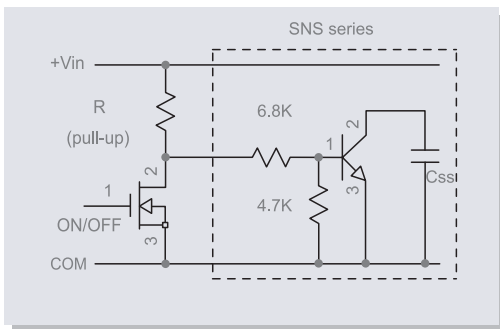

Fig6. Driving the ON/OFF Control Pin with an external pull up resistor

Remote Sense

The Remote sense function corrects a voltage drop caused by conduction loss(IxR). Remote sense pin should be connected to Vout(+) at the point where regulation is desired. Trim and sense function can increase a output voltage, but adjusted output power must not beyond its maximum rating. If sense function is not being used, leave sense pin disconnected.

Output Voltage Trimming

Output voltage can be variable by using trim pin. With additional fixed resistor between trim pin and Vout pin, designer can drop output voltage. Also, designer can increase output voltage by inserting fixed resistor between trim pin and common pin Fig7.

The table shows a equation for making specific output voltage. Trim-resistor values also can be calculated by those equations in the table. Output Voltage Trimming Range is ±10% of rated output voltage.

Output Voltage	Trim Equations
1 V	$R_{up} = \frac{1701}{75(V_o - 0.7) - 22.68}$
	$R_{down} = \frac{2430(V_o - 0.7)}{22.68 - 75(V_o - 0.7)}$
1.5 V	$R_{up} = \frac{635.04}{28(V_o - 0.7) - 22.68}$
	$R_{down} = \frac{907.2(V_o - 0.7)}{22.68 - 28(V_o - 0.7)}$
1.8 V	$R_{up} = \frac{464.94}{20.5(V_o - 0.7) - 22.68}$
	$R_{down} = \frac{664.2(V_o - 0.7)}{22.68 - 20.5(V_o - 0.7)}$
2.5 V	$R_{up} = \frac{281.232}{12.4(V_o - 0.7) - 22.68}$
	$R_{down} = \frac{401.76(V_o - 0.7)}{22.68 - 12.4(V_o - 0.7)}$
3.3 V	$R_{up} = \frac{196.4088}{8.66(V_o - 0.7) - 22.68}$
	$R_{down} = \frac{280.584(V_o - 0.7)}{22.68 - 8.66(V_o - 0.7)}$
5.0 V	$R_{up} = \frac{120.204}{5.3(V_o - 0.7) - 22.68}$
	$R_{down} = \frac{171.72(V_o - 0.7)}{22.68 - 5.3(V_o - 0.7)}$

Fig6. Trim Equation

Note : Resister values are in kΩ. Accuracy of adjustment is subject to tolerances of resistors and factory-adjusted, Initial output Accuracy. Vo=desired output voltage.

Non-isolated DC-DC POL converter

SNS10A-12

NOV.05.2004

Efficiency vs. Load Current

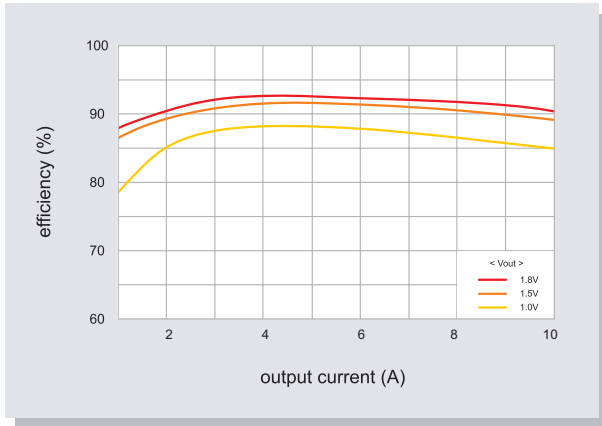

Fig8. Efficiency and Load Current (Vin=5V)

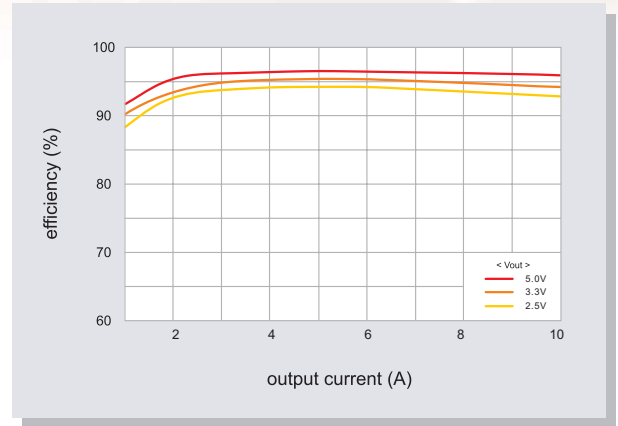

Fig9. Efficiency and Load Current (Vin=5V)

Output Current vs. Ambient Temperature

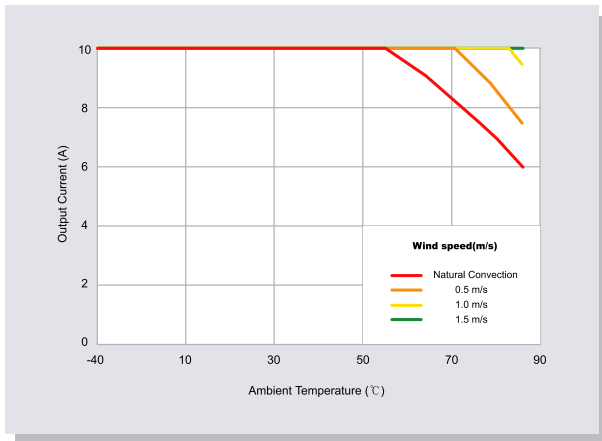

Fig10. Derating Output Current vs. Local Ambient Temperature and Airflow (Vin=12V, Vo=1.0V)

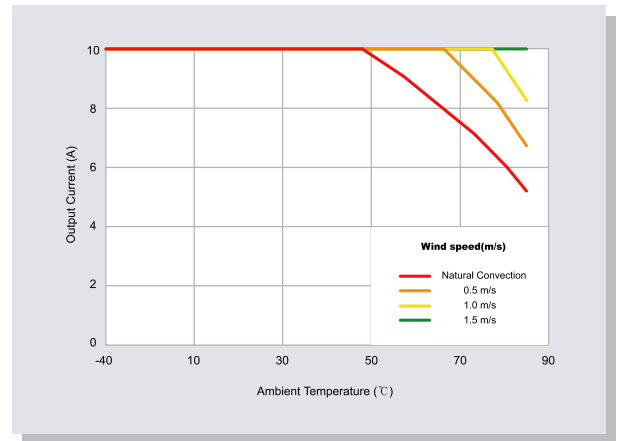

Fig11. Derating Output Current vs. Local Ambient Temperature and Airflow (Vin=12V, Vo=5.0V)

Non-isolated DC-DC POL converter

SNS10A-12

NOV.05.2004

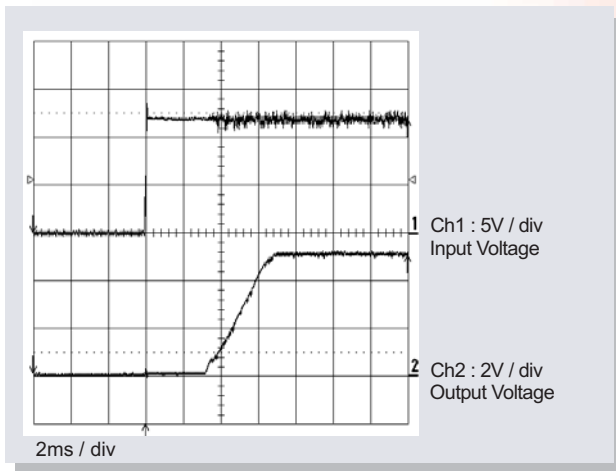

Fig12. Start-up with Application of Vin
($V_o = 5V$, $I_o = 10A$)

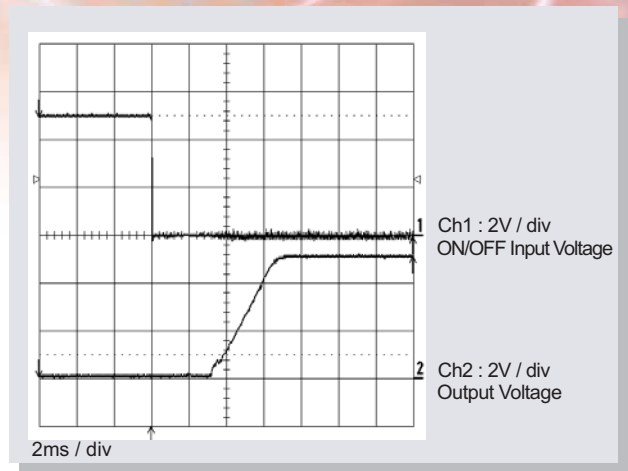

Fig13. Start-up Using Remote ON/OFF with Prebias
($V_o = 5V$, $I_o = 10A$)

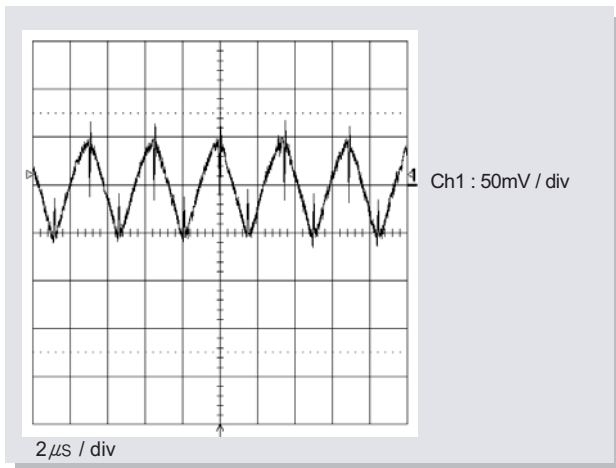

Fig14. Input Reflected Ripple Voltage
($V_o = 5V$, $I_o = 10A$, $C_{in} = 100\mu F \times 2$, $L_{in} = 1\mu F$)

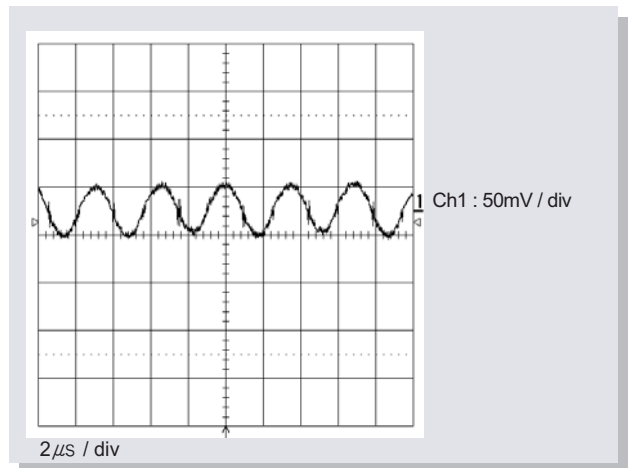

Fig15. Output Voltage Ripple & Noise
($V_o = 5V$, $I_o = 10A$)

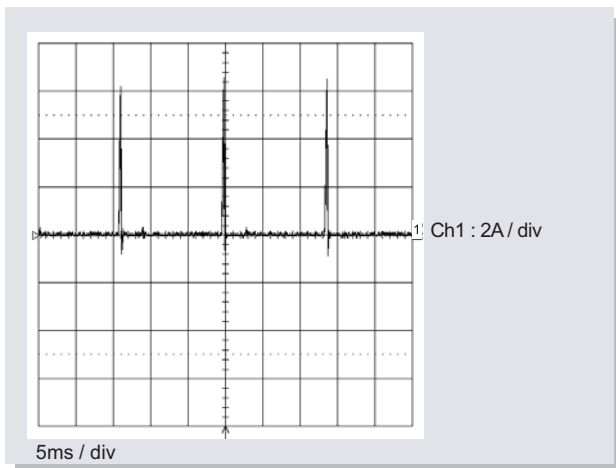

Fig16. Input Current with Short Circuit at Output
($V_o = 5V$, $I_o = 10A$)

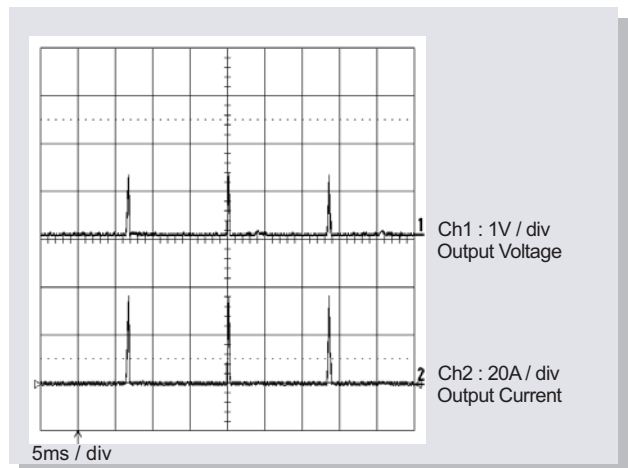

Fig17. Output Current & Voltage with short Circuit at Output
($V_o = 5V$, $I_o = 10A$)