

C 200

C 200 Series AC/DC Converters

Total power **200 Watts**
Input voltages **AC 90~132V**
 AC 170~264V (or DC240~340V)
#of outputs **Single output**



SPECIAL FEATURES

- CE Marking
- Small, compact size
- Surface mounting technology
- High efficiency
- Selected input voltage
- Built - in EMI filter
- Inrush current limit
- Adjustable output voltage (Output1)
- Output over current protection
- Output over voltage protection
- Over temperature protection
- Low output ripple & noise
- Isolated output
- 2 Years warranty

ENVIRONMENTAL

- Operating temperature range -10 ~60
- Storage temperature range -20 ~70
- Humidity 20%~90%RH
- Vibration 10~55Hz at 2G 3minutes period
- Impact 20G for 11ms, once on each X, Y and Z-axis
- Cooling method Natural air
- MTBF (MIL-HDBK-217F) 1.3 x 10⁵ hrs
- Safety Approved CE (EN60950) through TÜV
meets UL 60950 / CSA C22.2
- Noise meets CISPR22-B
FCC class B

ELECTRICAL SPECIFICATIONS

INPUT	<ul style="list-style-type: none"> · Voltage CS 200L - AC90~132V (Note1) CS 200 - AC 170~264V (or DC 240~340V) (Note2) · Current 2.3A max. (CS 200) / 4.4A max. (CS 200L) · Frequency 47~440Hz max. (50~60Hz typ.) · Efficiency 87% Typ. · Inrush current (at cold start) 20A max. @ 110VAC (CS 200L) / 40A max. @ 220VAC (CS 200) · Leakage current 0.5mA max. @ 110VAC (CS 200L) / 0.75mA max. @ 220VAC (CS 200)
OUTPUT	<ul style="list-style-type: none"> · Voltage adj. Range ± 10% typ. · Ripple and noise 1% max. · Line regulation ± 1% max. · Load regulation ± 1% max. · Dynamic load regulation ± 3% max. · Temperature drift ± 1% typ. · Rising time 100ms max. · Holding time 17ms min.
PROTECTION CIRCUIT	<ul style="list-style-type: none"> · Over current protection over 105% of rating (Auto-restart) · Over voltage protection 115~140% of rating (Latch-up mode) · Over temperature protection 80 min. (Latch-up mode)
ELECTRICALLY ISOLATED	<ul style="list-style-type: none"> · Input - Output AC 3KV, 1minute, 10mA / DC 500V, 100MOhms min. · Input - FG AC 2KV, 1minute, 10mA / DC 500V, 100MOhms min. · Output - FG AC 0.5KV, 1minute, 10mA / DC 500V, 70MOhms min.

NOTE 1. For cases where conformance to various safety specs (CE) are required, input voltage and frequency range will be 100-120VAC, 50/60Hz.
 2. For cases where conformance to various safety specs (CE) are required, input voltage and frequency range will be 200-240VAC, 50/60Hz.

Ordering Information

Input	Output	Maximum Power	Ripple&Noise max	Efficiency Typ.	model Number
AC 90~132V	+3.3V@40.0A	132.0W	80mVp-p	80%	CS200L-3R3 CS200L-5 CS200L-12 CS200L-15 CS200L-24 CS200L-48
	+5.0V@40.0A	200.0W	100mVp-p	83%	
	+12.0V@16.8A	201.6W	120mVp-p	86%	
	+15.0V@13.5A	202.5W	150mVp-p	86%	
	+24.0V@8.4A	201.6W	200mVp-p	87%	
	+48.0V@4.2A	201.6W	300mVp-p	88%	
AC 170~264V (or DC 240~340V)	+3.3V@40.0A	132.0W	80mVp-p	81%	CS200-3R3 CS200-5 CS200-12 CS200-15 CS200-24 CS200-48
	+5.0V@40.0A	200.0W	100mVp-p	84%	
	+12.0V@16.8A	201.6W	120mVp-p	87%	
	+15.0V@13.5A	202.5W	150mVp-p	87%	
	+24.0V@8.4A	201.6W	200mVp-p	88%	
	+48.0V@4.2A	201.6W	300mVp-p	89%	

Pin assignments

Connector	Single
CN 1	1. AC(N)
	2. AC(L)
	3. FG
	4. -V
	5. -V
	6. +V
	7. +V

Derating curve

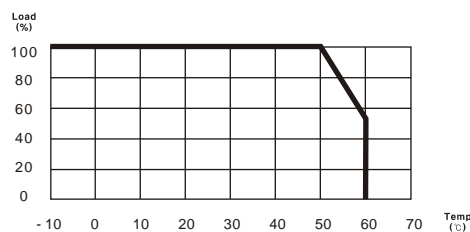

Dimensions

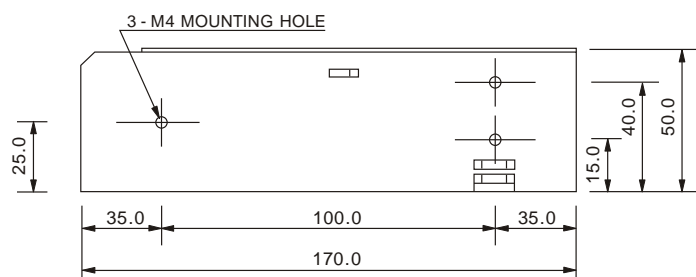
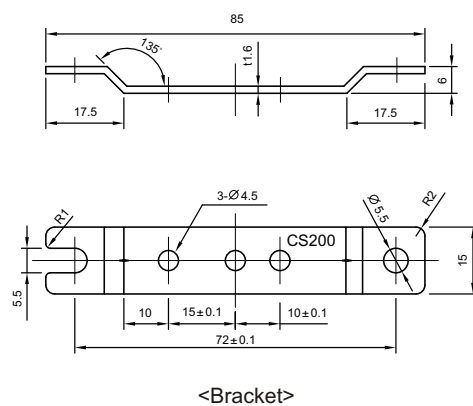
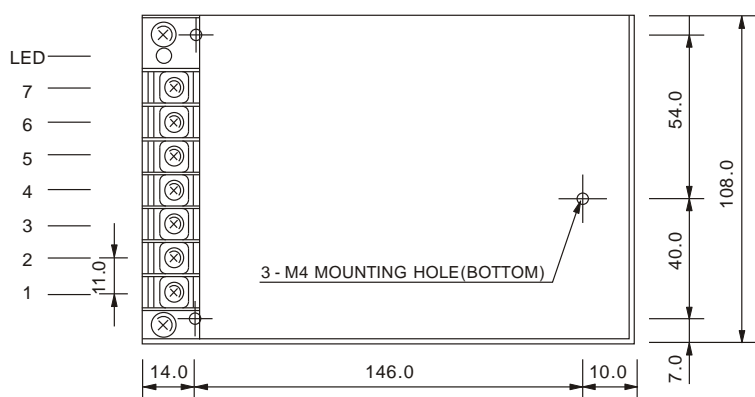

NOTES

1. All dimensions are mm.
2. Weight : 950g or less (single)
3. Mounting holes(6) for M4 screw, which should not enter the supply surface by more than 3.5mm.